

Supporting Kits

FIBREROUTE 240MM(9.45 INCH) CABINET/RACK MOUNTING KIT

Aginode Ref: N350.003SMR2

Aginode Fibre Trunking System provides a dedicated pathway for fibre optic cables and cords to protect them from accidental damage. The system offers a flexible, high-capacity solution for data centre containment which is easy to install and reconfigure to meet future needs.

- Mounting kits available for various data centre installation environments
- Mounting on top of the Cabinet/Rack
- Adjustable according to cabinet height

Cable Tray mounting kit includes supporting bottom, screws . N350.003SMR2 is available for 240mm(9.45 inch) series. The bottom height can be adjustable from 53mm(2.1") to 200mm(7.87").

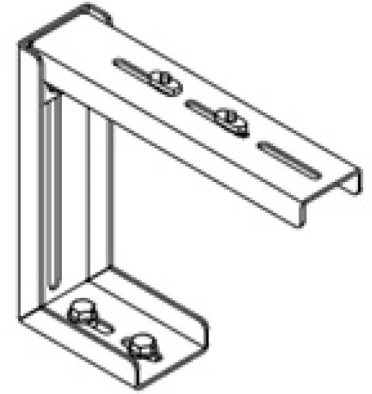

STANDARDS

EN 50173-5
ISO/IEC 24764

FIBREROUTE 240mm(9.45 inch) Cabinet/Rack Mounting Kit

Characteristics

结构特性

颜色	金属色
材料	钢

尺寸特性

近似净重量	1.5 kg
-------	--------

使用特性

操作温度, 范围	-25...60 °C
存储温度范围	-45...60 °C