

# essential-OF MT LSZH 4-24C - APAC

ESSENTIAL-OF MICRO TUBE CABLE 8F LSZH SINGLE MODE OS2 G.652.D 9/125 YELLOW

**Aginode Ref:** N274.MT08Y

- Micro Tube optical fiber cable
- Small, but mechanical strong cable
- Designed for splicing with pigtails
- 8 fibers

## Description and Application

The new Micro Tube technology from Aginode allows to manufacture a flexible and small tube. This Micro Tube is the central part of the new “Essential-OF Micro Tube Cable” design, it contains 4-24 fibers with a fiber diameter of 250 um. Termination of these fibers is done with splicing with pigtails. Aramid yarns provide additional strength and make the cable installer friendly. The combination of the Micro Tube technology and aramid yarns result in a mechanical robust, but also small and flexible cable. This makes it an optimized cable for datacenters and backbones. The small bending radius of the Essential-OF Micro Tube Cable makes the cable easy to arrange in patch panels, in cable trays and in ducts. The Essential-OF Micro Tube Cable complies with the indoor fire requirements. Since there is no drip effect of the very limited amount of gel the cable is optimized for both horizontal and vertical installations.

## Construction

Legend accompanying the cross-section drawing:

1. Aramid yarn
2. 250um fiber
3. Inner jacket
4. LSZH Outer Jacket

## Characteristics

- Micro Tube Cable design for easy installation
- Indoor cable for horizontal and vertical installations
- Fire retardant (IEC 60332-3-24)
- All dielectric design
- Designed for termination by splicing
- Aramid yarns for ease of handling and as strength element
- Available in 4, 6, 8, 12 and 24 fiber

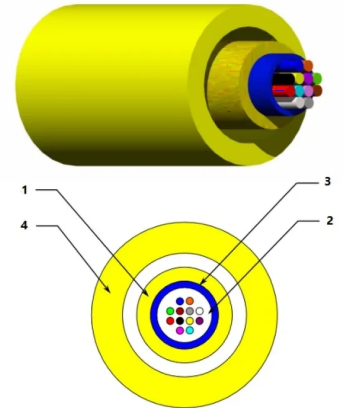

## STANDARDS

ANSI/TIA-568-C.3  
IEC 60332-1  
IEC 60332-3-24 Cat.C  
IEC 60793-2-10  
ISO/IEC 11801

All drawings, designs, specifications, plans and particulars of weights, size and dimensions contained in the technical or commercial documentation of Aginode is indicative only and shall not be binding on Aginode or be treated as constituting a representation on the part of Aginode.

# essential-OF Micro Tube Cable 8F LSZH Single mode OS2 G.652.D 9/125 Yellow

## Characteristics

### Construction characteristics

Colour	Yellow
Fiber optic type	SM (G.652D)

### Dimensional characteristics

Outer Diameter	3.7 mm
Number of optical fibres	8

### Mechanical characteristics

Mechanical resistance to impacts (IEC 60794-1-E4)	100 impacts of 1 N.m
Crush resistance (IEC 60794-1-E3)	1000 N/100mm
Maximum pulling force (IEC 60794-1-2-E1)	440 N

### Usage characteristics

Operating temperature, range	-20...60 °C
Minimum dynamic operating bending radius	74.0 mm
Minimum static operating bending radius	37 mm
Storage temperature, range	-20...60 °C
Installation temperature, range	0...60 °C