

# Supporting Kits

## FIBREROUTE 240MM(9.45 INCH) CABINET/RACK MOUNTING KIT

**Aginode Ref:** N350.003SMR2

Aginode Fibre Trunking System provides a dedicated pathway for fibre optic cables and cords to protect them from accidental damage. The system offers a flexible, high-capacity solution for data centre containment which is easy to install and reconfigure to meet future needs.

- Mounting kits available for various data centre installation environments
- Mounting on top of the Cabinet/Rack
- Adjustable according to cabinet height

Cable Tray mounting kit includes supporting bottom, screws . N350.003SMR2 is available for 240mm(9.45 inch) series. The bottom height can be adjustable from 53mm(2.1") to 200mm(7.87").

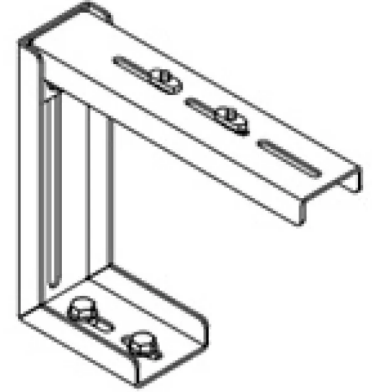

### STANDARDS

EN 50173-5  
ISO/IEC 24764

# FIBREROUTE 240mm(9.45 inch) Cabinet/Rack Mounting Kit

## Characteristics

### Construction characteristics

Colour	Metalic
Material	Steel

### Dimensional characteristics

Approximate net weight	1.5 kg
------------------------	--------

### Usage characteristics

Operating temperature, range	-25...60 °C
Storage temperature, range	-45...60 °C