

Document : ABS1541/B  
Date : 28/02/2024

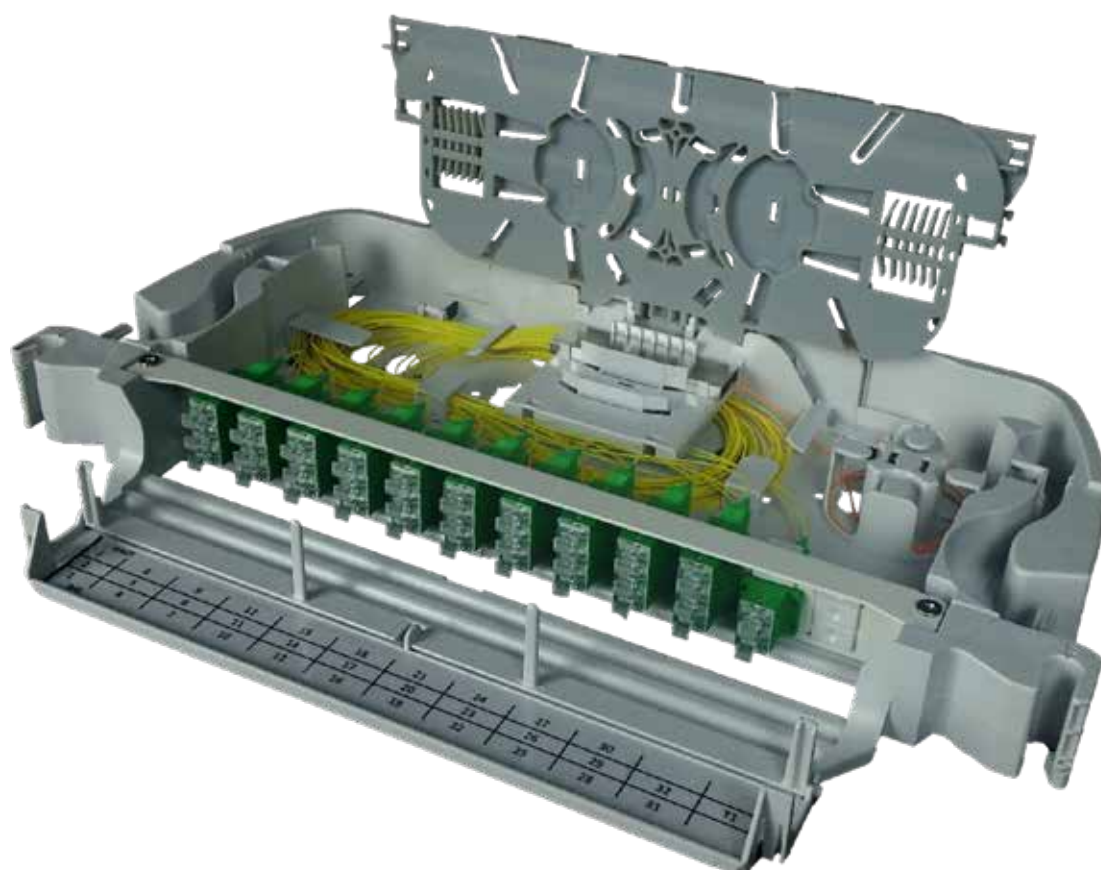

#smartconnection

NOTICE / INSTRUCTIONS



# XPLORES™ 1U

Module de couplage 1x2 à 1x64 (SC et LC)  
*Splitter module 1x2 to 1x64 (SC and LC)*

[www.aginode.net](http://www.aginode.net)



# Table des matières

## Table of contents

<b>1. DESCRIPTION</b>	
<b>OVERVIEW</b> .....	<b>4</b>
1.1. PRÉSENTATION DU PRODUIT	
<i>PRODUCT PRESENTATION</i> .....	4
1.2. CARACTÉRISTIQUES TECHNIQUES	
<i>TECHNICAL CHARACTERISTICS</i> .....	5
1.3. KITS FOURNIS	
<i>PROVIDED KITS</i> .....	6
<b>2. FIXATION DU PLATEAU</b>	
<b>FIXATION OF THE MODULE</b> .....	<b>7</b>
2.1. CONDITIONNEMENT	
<i>PACKAGING</i> .....	7
2.2. MISE EN PLACE DU DORMANT	
<i>INSTALLING THE FIXED CHASSIS</i> .....	8
2.3. MISE EN PLACE DE LA PLAQUE DE VERROUILLAGE	
<i>INSTALLING THE LOCKING PLATE</i> .....	9
2.4. MISE EN PLACE DU BATTANT	
<i>INSTALLING THE SWIVELING CHASSIS</i> .....	10
<b>3. RACCORDEMENT DU MODULE</b>	
<b>CONNECTION OF THE MODULE</b> .....	<b>11</b>
3.1. RACCORDEMENT PAR BRASSAGE	
<i>CONNECTED BY PATCHING</i> .....	11
3.2. RACCORDEMENT PAR ÉPISSURAGE	
<i>CONNECTION THROUGH SPLICING</i> .....	12
<b>4. FERMETURE DU BATTANT</b>	
<b>CLOSING THE MODULE</b> .....	<b>19</b>
<b>5. POSE D'UN CORDON</b>	
<b>INSTALLING PATCHCORD</b> .....	<b>20</b>
<b>6. ÉLÉMENTS PARTICULIERS DE MAINTENANCE</b>	
<b>SPECIAL PROCEDURES FOR MAINTENANCE</b> .....	<b>21</b>
6.1. REMPLACEMENT D'UN RACCORD	
<i>ADAPTER REPLACEMENT</i> .....	21
6.2. PRINCIPE DE DÉPOSE DU PLATEAU	
<i>MODULE REPLACEMENT</i> .....	22
<b>7. ANNEXES</b>	
<b>ANNEX</b> .....	<b>23</b>
7.1. MISE EN PLACE D'UN COUPLEUR	
<i>INSTALLATION OF A SPLITTER</i> .....	23

7.2. AUTRES KITS À APPROVISIONNER EN SUPPLÉMENT  
*OTHERS KITS TO BE ORDERED SEPARATELY* .....25

7.3. FIXATION AVEC ÉCROUS CAGES SUR MONTANTS 19"  
*CAGE NUTS FIXATION ON 19" FRAMES* .....26

7.4. FIXATION DU KIT DE GUIDAGE  
*ROUTING KIT FIXATION*.....27

**8. INSTRUCTION DE FIN DE VIE**  
***END LIFE INSTRUCTION*** ..... **29**

**9. TRAÇABILITÉ**  
***TRACEABILITY*** ..... **29**

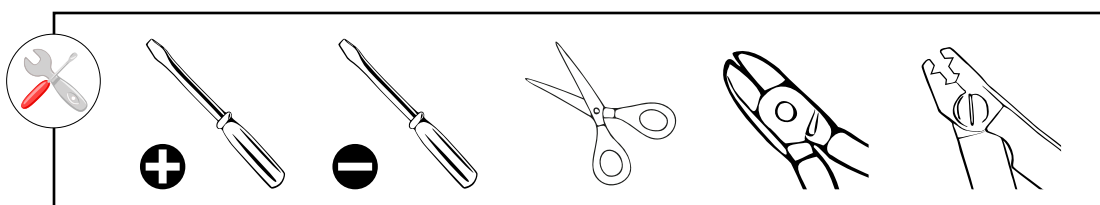

## 1. DESCRIPTION OVERVIEW

### 1.1. Présentation du produit Product presentation

- |    |  |    |                                 |
|----|--|----|---------------------------------|
| 1- | Capot de protection                            | 1- | Protective cover                |
| 2- | Zone de gestion des surlongueurs               | 2- | Overlength coiling area         |
| 3- | Équerre de fixation (dormant)                  | 3- | Fixing bracket (fixed chassis)  |
| 4- | Panneau frontal de brassage (jusqu'à 64 en LC) | 4- | Front patch panel (up to 64 LC) |
| 5- | Loquet   | 5- | Lock                            |
| 6- | Plaque de verrouillage 19"                     | 6- | 19" locking plate               |
| 7- | Zone de lovage                                 | 7- | Coiling area                    |
| 8- | Cassette (24 épissures)                        | 8- | Cassette (24 splices)           |
| 9- | Ensemble optique pivotant (battant)            | 9- | Swiveling chassis               |

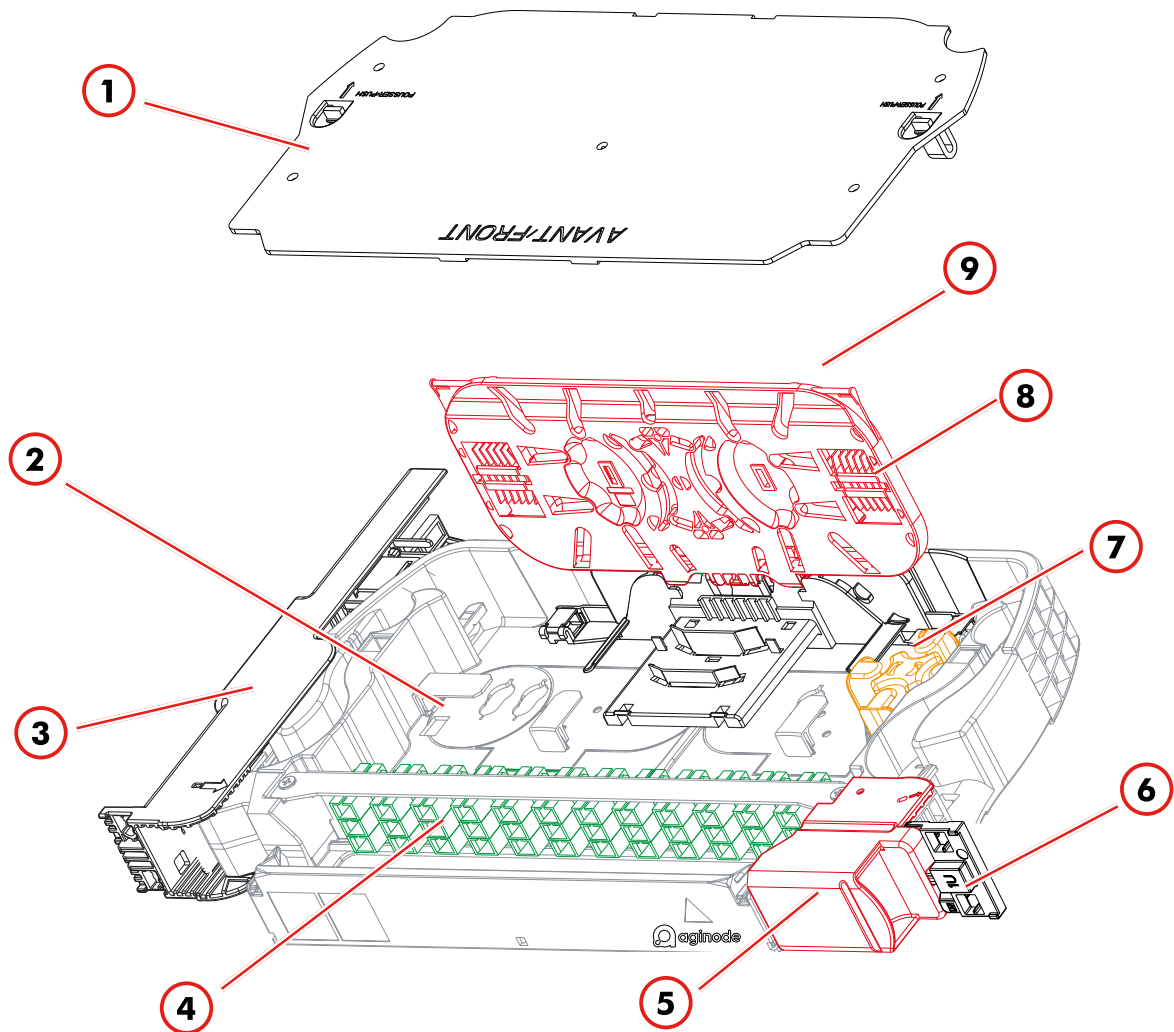

Les schémas représentent un module axe à gauche.







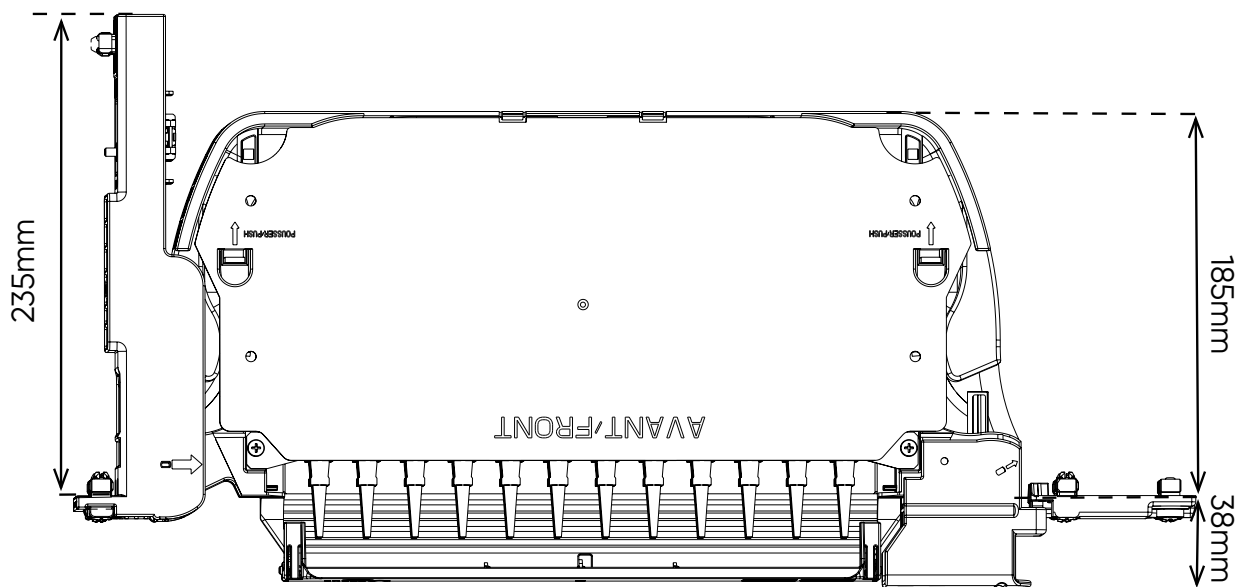
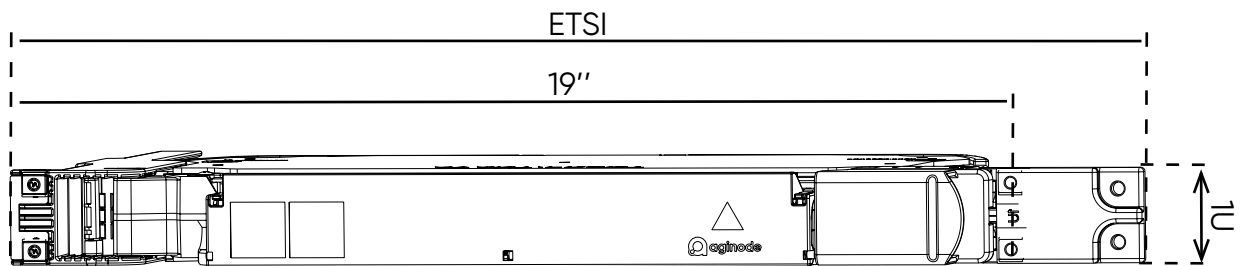



The drawings represent a left axis module.

1.2. Caractéristiques techniques  
*Technical characteristics*





- |                |                  |           |                   |
|----------------|------------------|-----------|-------------------|
| - Poids :      | 1,4kg            | - Weight: | 1.4kg             |
| - Hauteur :    | 1U               | - Height: | 1U                |
| - Largeur :    | Standard19"/ETSI | - Width:  | 19"/ETSI standard |
| - Profondeur : | 185mm            | - Depth:  | 185mm             |

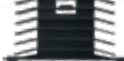

1.3. Kits fournis  
*Provided kits*

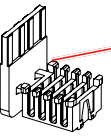
		Description	Qté / Qty
Kit de fixation 19" standard (□↑9,5mm):		<i>Standard 19" fixation kit (□↑9.5mm):</i>	
<b>a</b>	- Douilles	 - Sockets	<b>5</b>
<b>b</b>	- Pions	 - Pawns	<b>5</b>
<b>c</b>	- Plaque de verrouillage 19" 1U	 - Locking plate 19" 1U	<b>1</b>
Kit de fixation 19" (□↑8,3mm):		<i>19" fixation kit (□↑8.3mm):</i>	
<b>d</b>	- Écrous cages (□↑8,3mm)	 - Cage nuts (□↑8.3mm)	<b>5</b>
<b>e</b>	- Vis hexagonales	 - Hexagonal screws	<b>5</b>
<b>f</b>	- Rondelle	 - Washer	<b>1</b>
<b>g</b>	- Plaques de renfort	 - Reinforcing plates	<b>2</b>
Kit bobine :		<i>Spool kit:</i>	
<b>h</b>	- Anneau bobine (Ø 30 mm)	 - Spool (Ø 30 mm)	<b>1</b>
<b>i</b>	- Support bobine	 - Spool support	<b>1</b>
<b>j</b>	- Clip bobine	 - Spool clip	<b>1</b>
<b>k</b>	- Vis cylindrique large fendue	 - Cylindrical slotted head screw	<b>1</b>
Kit coupleurs:		<i>Splitters kit:</i>	
<b>l</b>	- Support coupleur(s) 1:4, 1:8, 1:16	 - 1:4, 1:8, 1:16 splitter(s) holder	<b>2</b>

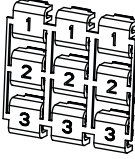
Liste des peignes fournis et diamètre d'utilisation. *Combs list and fitting diameter.*

Numéro du peigne <i>Comb number</i>		Ø des tubes et pigtails <i>Ø of tubes or pigtails</i>	Qté <i>Qty</i>
Peigne en mousse <i>Foam comb</i>		Ø 250µm à Ø 1,3mm	1
Peigne pour pigtails <i>Pigtails for comb</i>	 Outil Tool	Ø 900µm	1
Peigne plastique#5 <i>Plastic comb #5</i>		Ø 5mm	1
Peigne plastique #1 #2 #3 <i>Plastic comb</i>		Ø 1.6mm Ø 2.4mm Ø 2.8mm	3 3 3
Peigne plastique <i>Plastic comb</i>		Ø 2mm	1

**2. FIXATION DU PLATEAU**  
**FIXATION OF THE MODULE**

2.1. Conditionnement  
*Packaging*

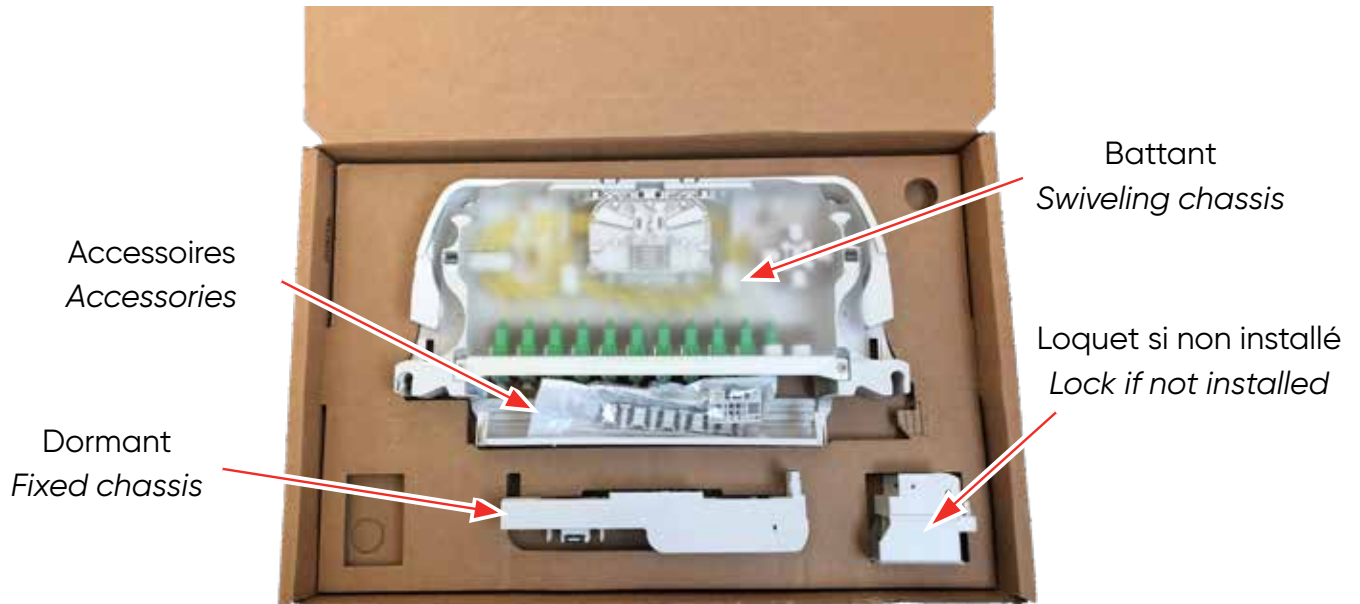

Mise en place du loquet côté opposé de l'axe de rotation.

*Installing the lock to the opposite of the rotation axis.*

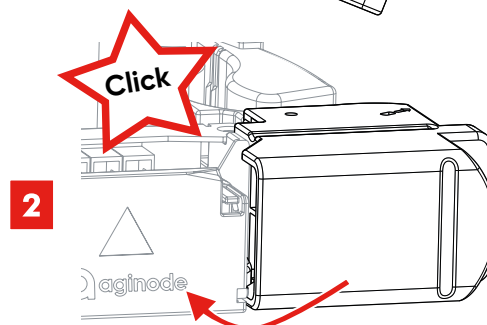
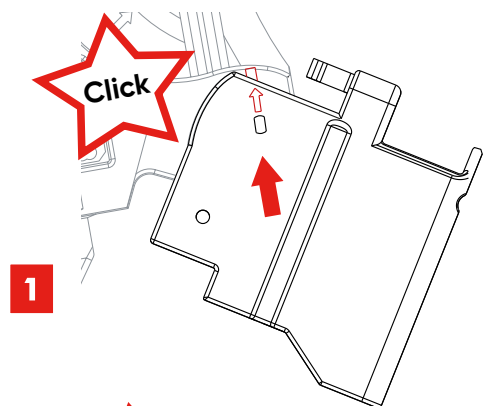
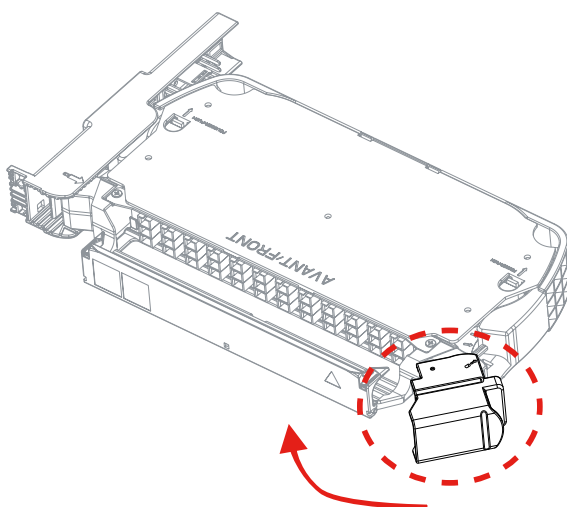

## 2.2. Mise en place du dormant Installing the fixed chassis

Standard  
Standard

19"

Dimension carrés  
Squares dimension

8,3mm

Anneaux intégrés  
Integrated spools

Oui/Yes



Si l'armoire n'est pas conforme au standard 19"  $\square\updownarrow 9,5\text{mm}$ , se reporter au chapitre 7 (annexes).

*If the cabinet is not compliant with the 19"  $\square\updownarrow 9.5\text{mm}$  standard, refer to the chapter 7 (annex).*

Kit de fixation 19" standard  
( $\square\updownarrow 9,5\text{mm}$ ).

Standard 19" fixation kit ( $\square\updownarrow 9.5\text{mm}$ ).



Enlever les appendices  
des douilles et des pions.  
*Remove the links between  
sockets and pawns.*

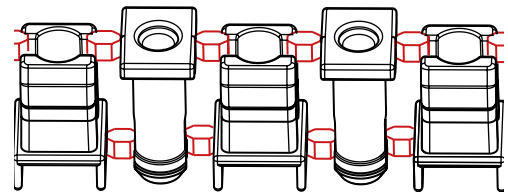

Mise en place des douilles (a)

Installing sockets (a)



Sens de la douille et du pion sur le  
montant avant (gauche et droit).

*Position of the socket and the pawn  
in the front frame (left and right).*

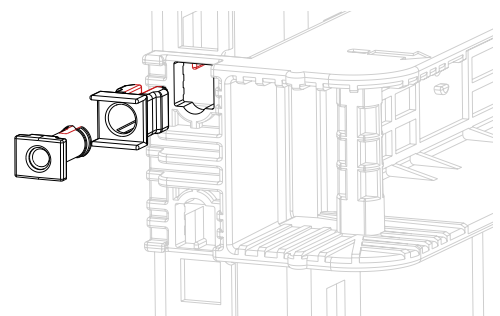

**1**

Montant avant gauche  
Left front frame



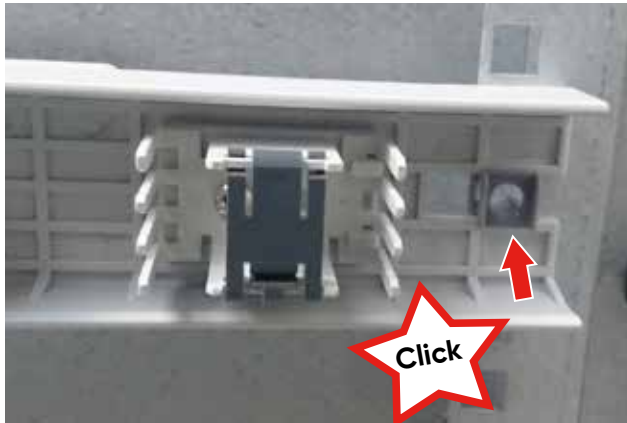

**2** Montant arrière  
Back frame

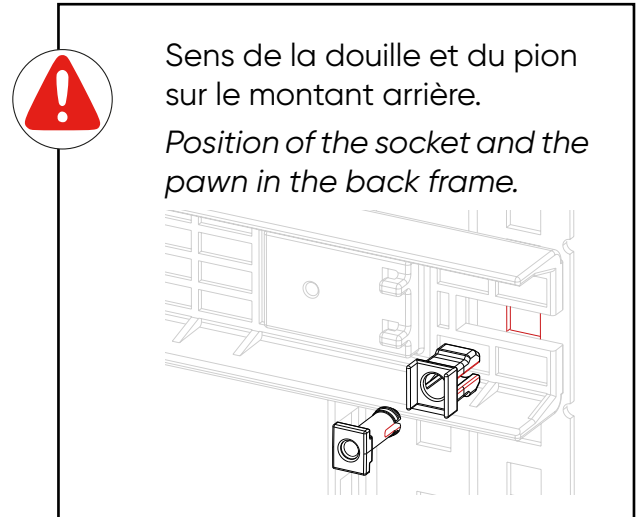

Mise en place des pions (b)



**3** Montant arrière  
Back frame

Installing pawns (b)



**4** Montant avant gauche  
Left front frame

2.3. Mise en place de la plaque de verrouillage  
Installing the locking plate

Mise en place des douilles (a + c)  
Installing sockets (a + c)



**1** Montant avant droit  
Right front frame

Mise en place des pions (b)  
Installing pawns (b)



**2** Montant avant droit  
Right front frame

2.4. Mise en place du battant  
*Installing the swiveling chassis*

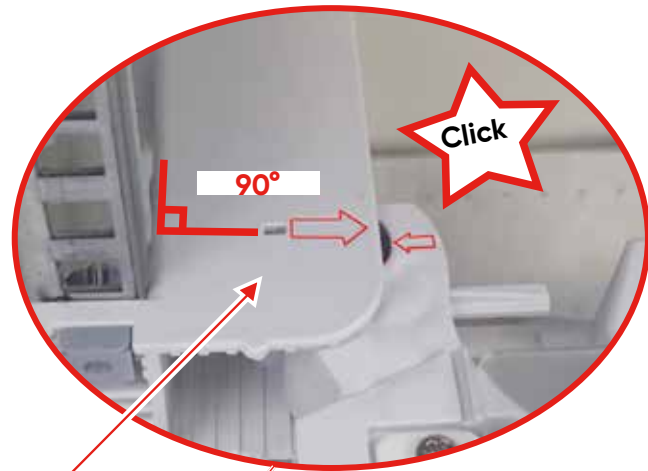

1

Angle de montage repéré par un index moulé  
*Mounting angle marked by molded index*



**Ne pas déclipper le battant après la mise en place.**

***Do not unclip the swiveling chassis after the installation.***



**2** Refermer le battant  
Close the swiveling  
chassis



**3** S'assurer du bon verrouillage  
Ensure to correct locking

### 3. RACCORDEMENT DU MODULE CONNECTION OF THE MODULE

#### 3.1. Raccordement par brassage Connected by patching

Coupleur: connection réseau par **brassage**  
Splitter: network connection by **patching**

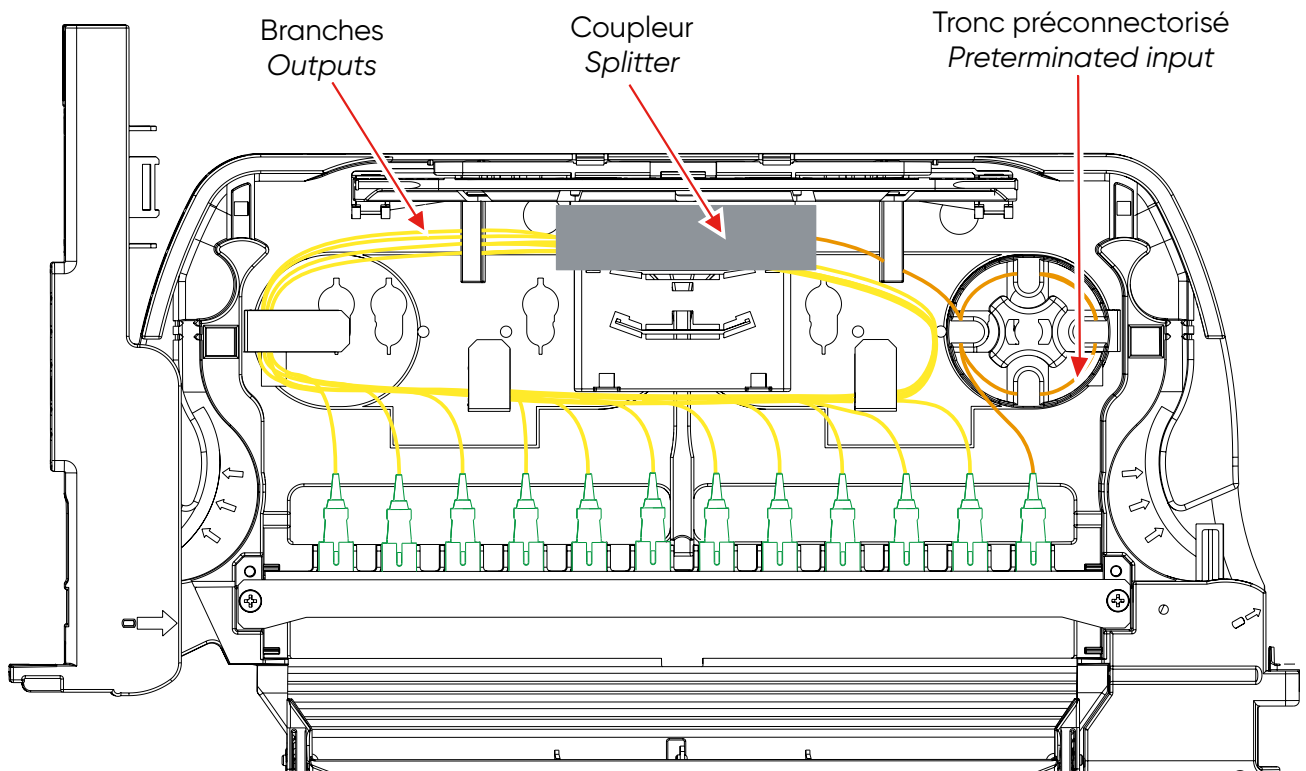

Tronc préconnectorisé axe à droite/gauche  
Right/left axis preterminated input

Exemple d'indications du panneau de raccordement  
*Exemple of a patch panel indications*

HAUT/UP	2	2	2	2	2	2	2	2	2	2	2	2
1	1	1	1	1	1	1	1	1	1	1	1	1
T1	T2	T3	T4	T5	T6	T7	T8	T9	T10	T11	T12	20243895
BAS/DOWN												

Emplacement des branches  
*outputs location*

Emplacement des troncs  
*Inputs location*

Tronc  
*Input*

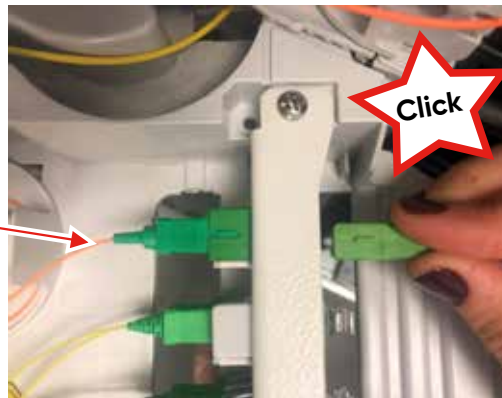

### 3.2. Raccordement par épissurage *Connection through splicing*

#### 3.2.1. Accès à l'organiseur *Access to the organiser*



**1** Ouvrir le battant  
*Open the swiveling chassis*

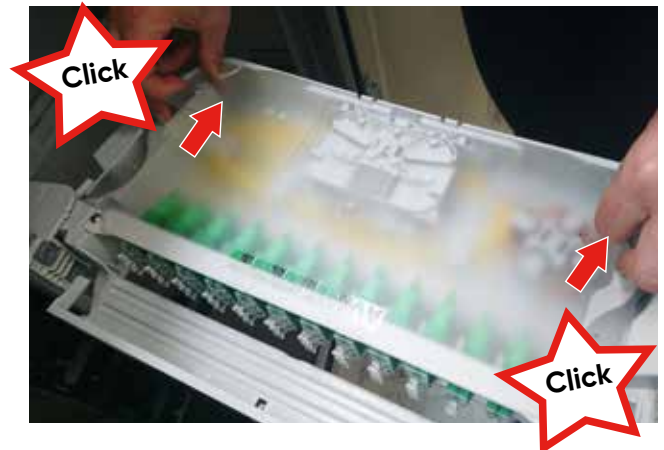

**2** Déclipper le capot  
*Unclip the cover*

#### 3.2.2. Préparation du câble ou du pigtail *Cable or pigtail preparation*

**1** Peigne métallique  
*Metallic comb*

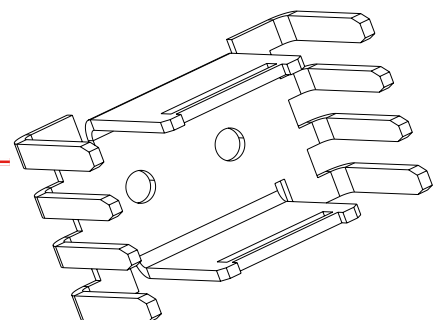

**2** Cas 1 : préparation d'un pigtail  
Case 1: preparation of a pigtail

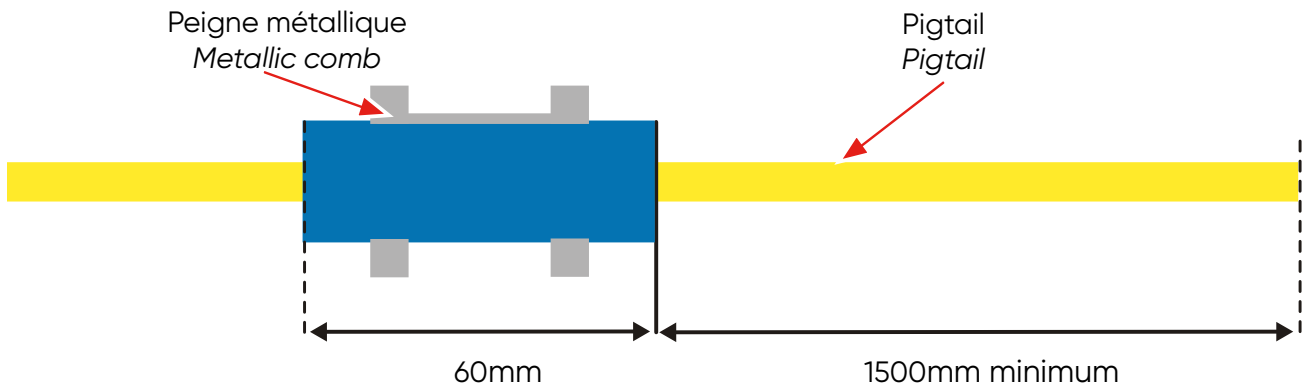

Cas 2: préparation d'un câble  
Case 2: preparation of a cable



Voir la notice du système d'épanouissement. *Refer to the clamping device instructions.*

Préparation du micromodule  
Preparation of the microbundle

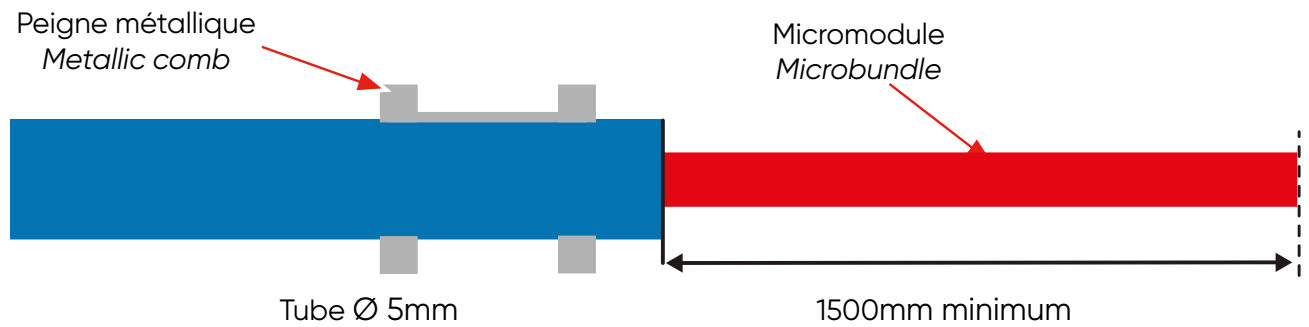

Préparation du looetube  
Preparation of the looetube

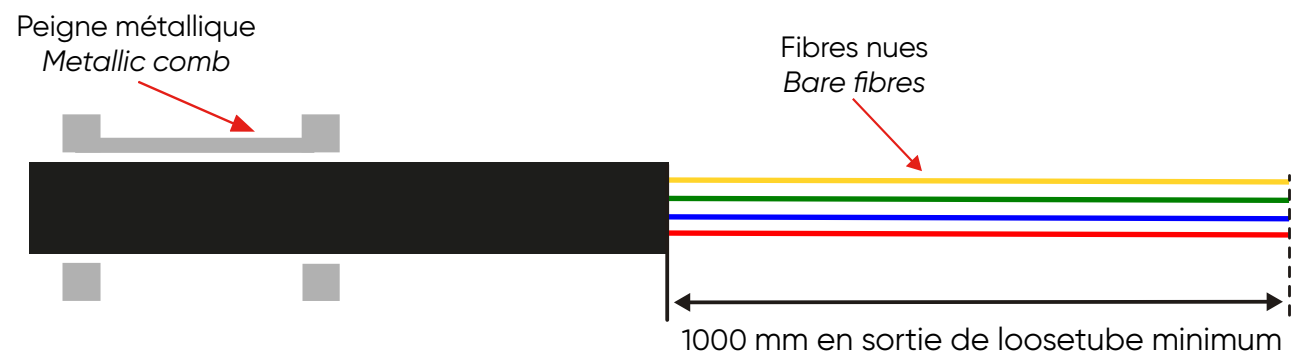

3.2.3. Fixation arrière du pigtail, micromodule ou loosetube  
*Loosetube, microbundle or pigtail back fixation*

Cas 1 : fixation d'un pigtail  
*Case 1: fixation of the pigtail*

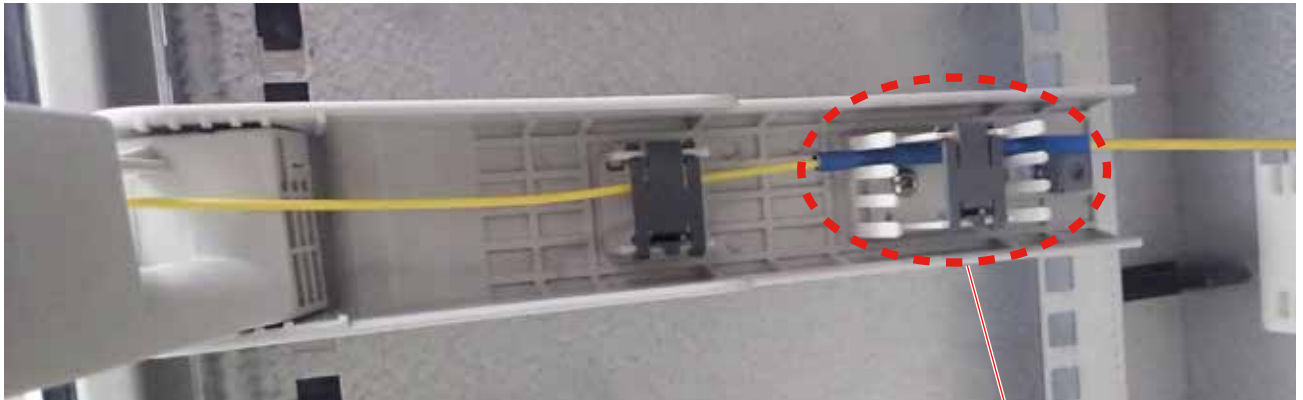

Maintien des pigtails  
*Maintain the pigtails*

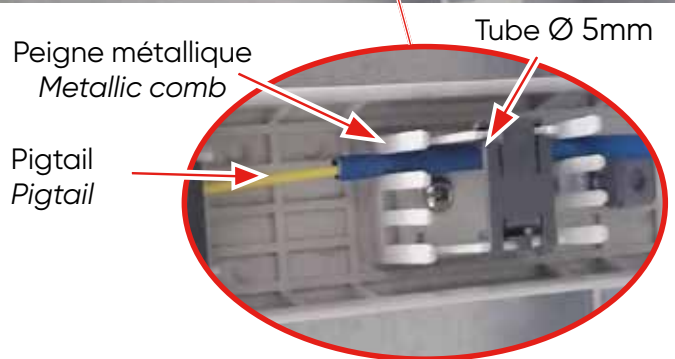

Cas 2 : fixation d'un micromodule ou loosetube  
*Case 2: fixation of the microbundle or loosetube*

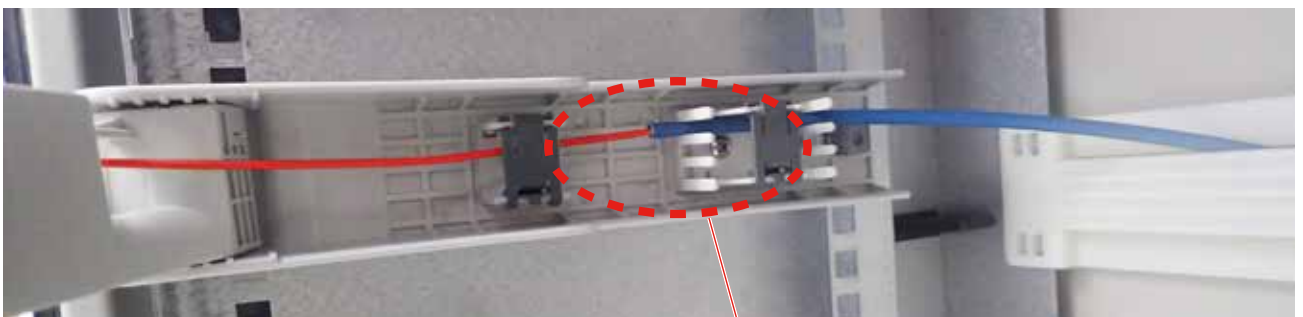

Micromodule ou loosetube  
*Microbundle or loosetube*

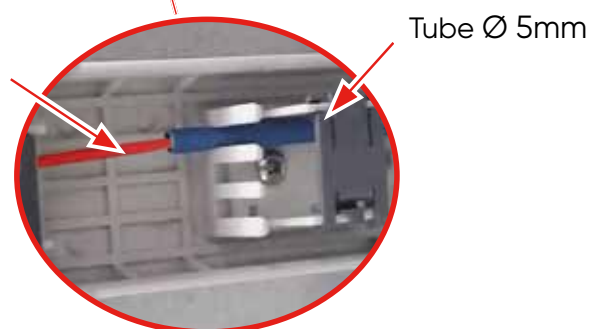

### 3.2.4. Cheminement des troncs des coupleurs Routing of splitters inputs

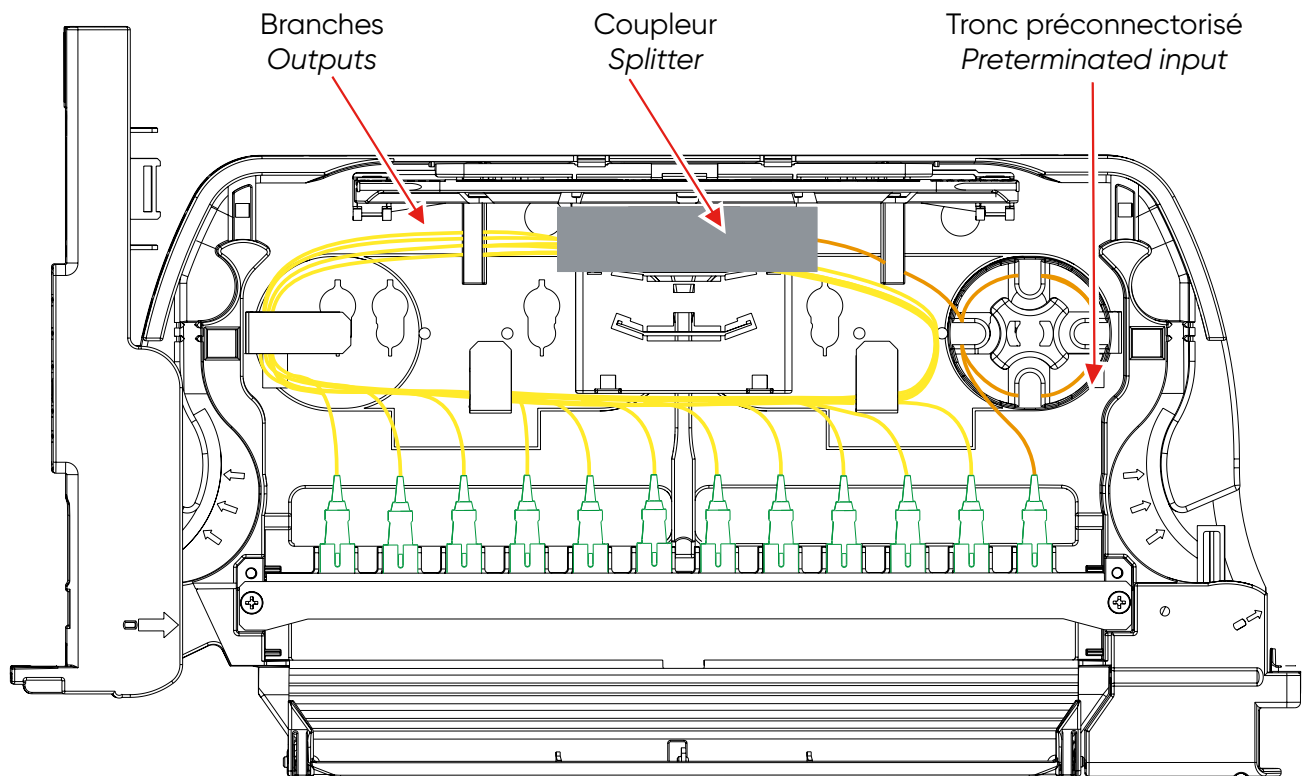

- 1- Déconnecter le tronc du coupleur
- 2- Couper la fiche
- 3- Router le tronc du coupleur jusqu'à la cassette

- 1- Disconnect the splitter input
- 2- Cut the connector
- 3- Routing the splitter input to the splice cassette as in the following drawings

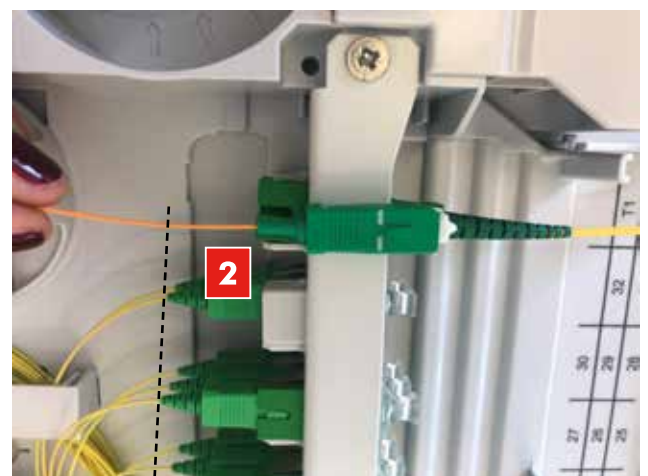
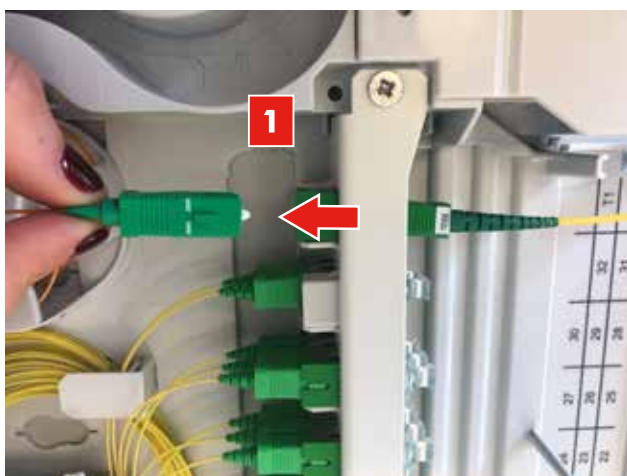

- 3** Cheminement des troncs: cas d'un tronc à souder pour un tiroir monté avec un axe à gauche  
*Routing of inputs: case of an input to be spliced for a left-axis configuration*

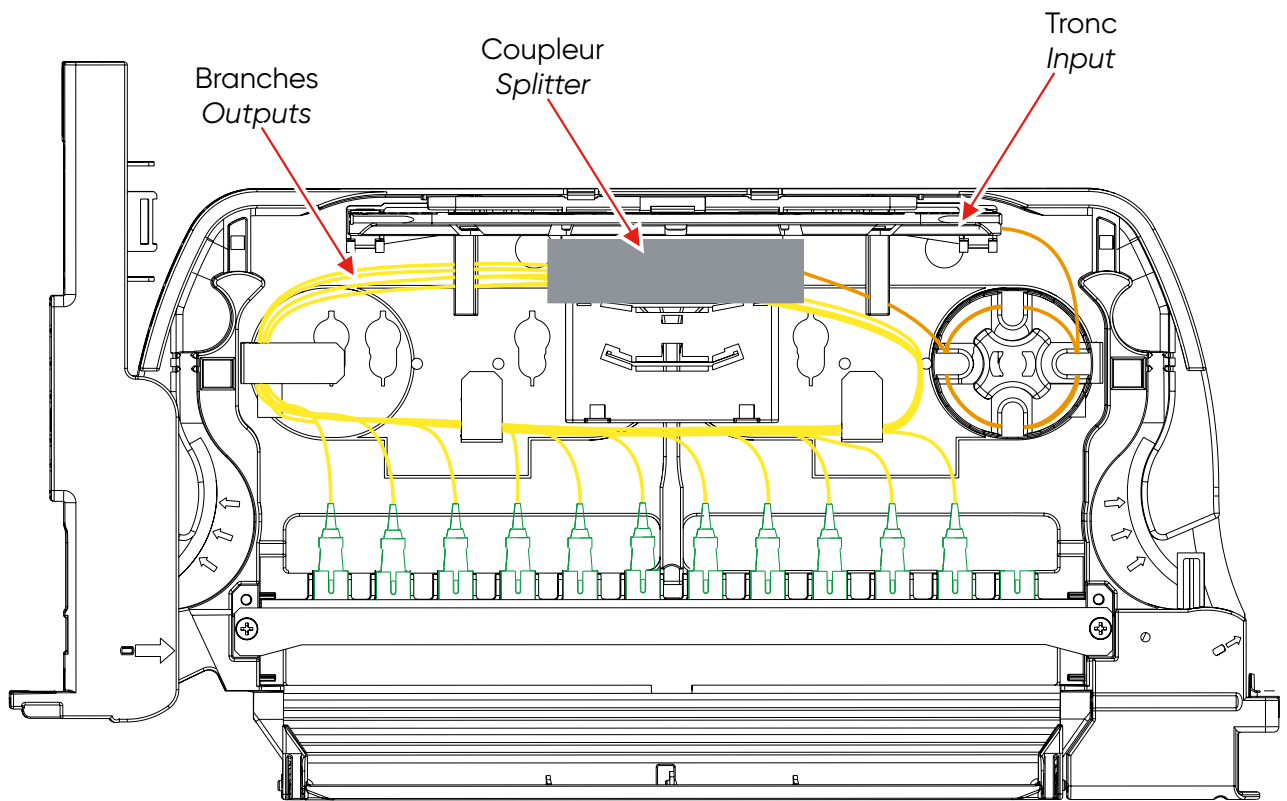



3.2.5. Cheminement des fibres réseau jusqu'à l'organiseur  
*Routing network fibres to the organiser*

Cas 1 : avec les pigtails  
*Case 1: with the pigtails*

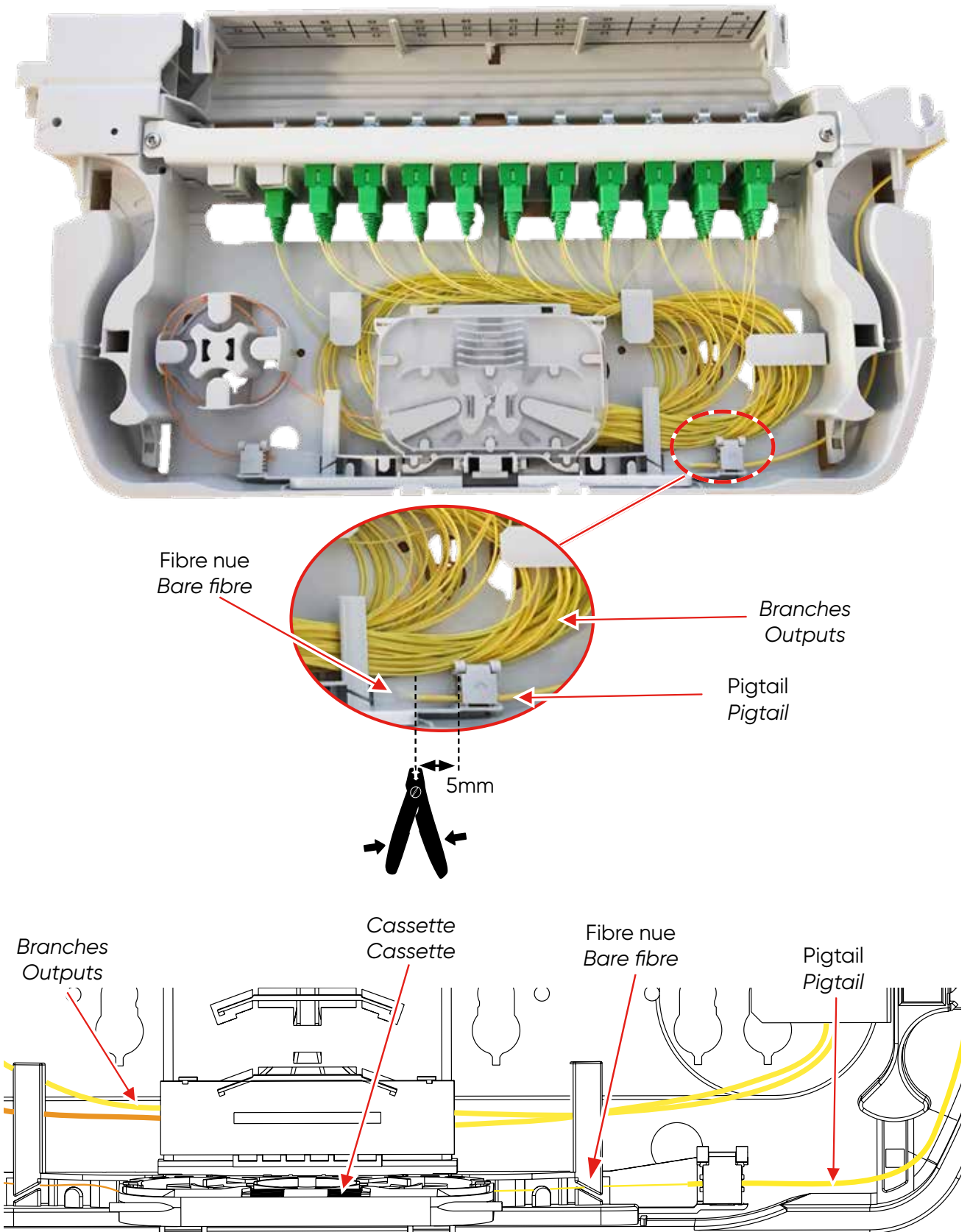

Cas 2 avec les micromodules ou loosetubes  
 Case 2 with the microbundles or loosetubes

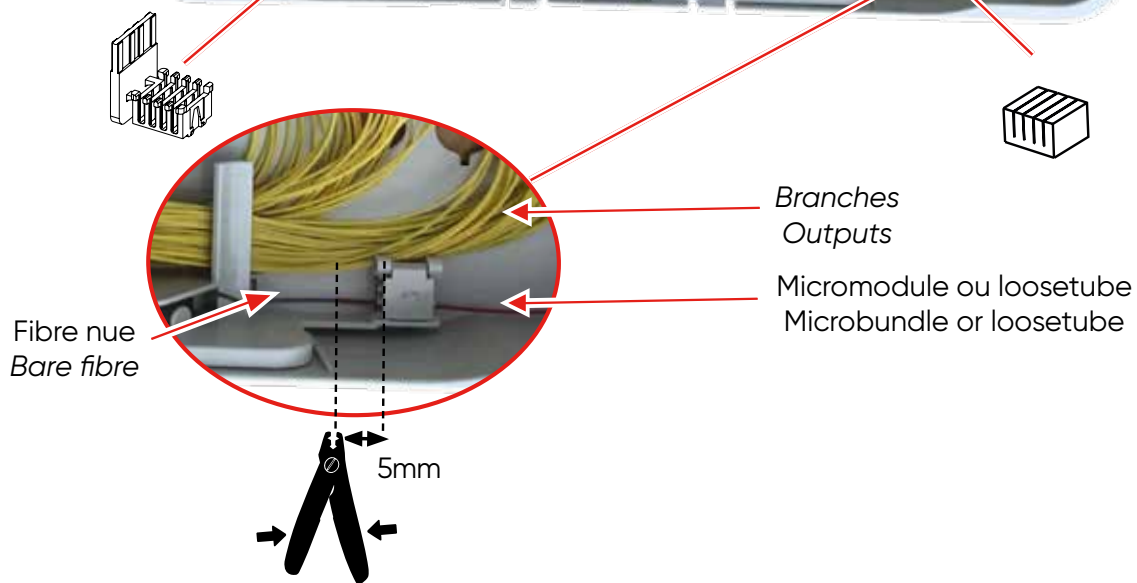
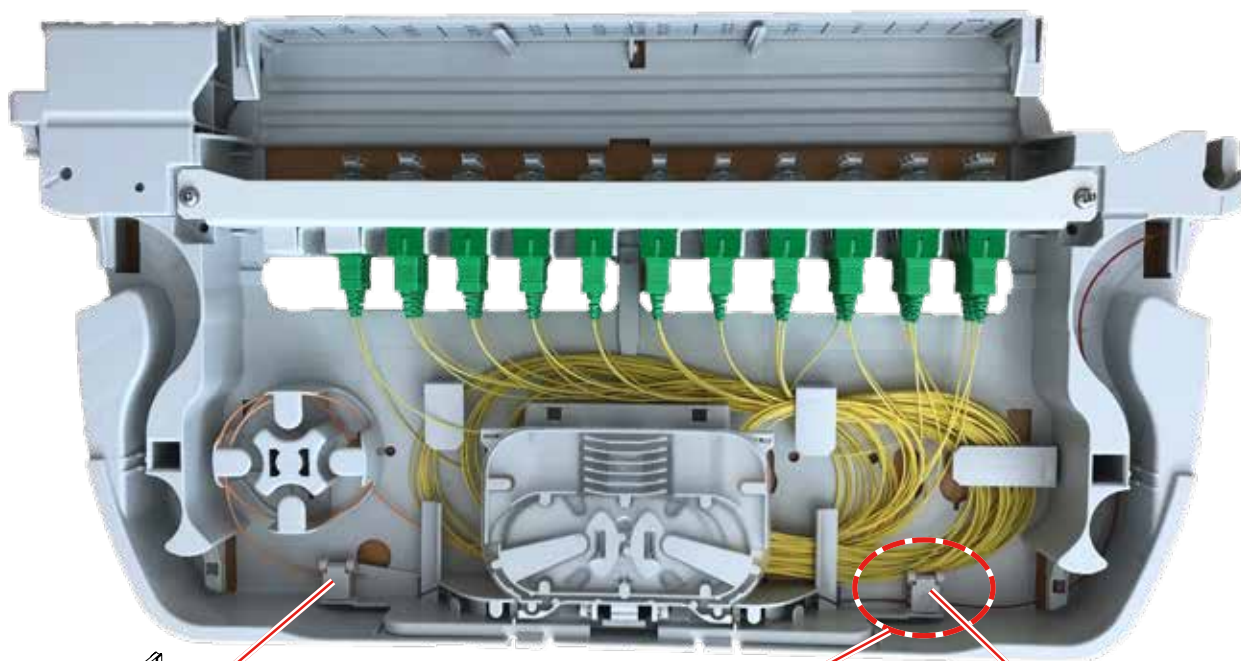

Réaliser l'épissure (compatibilité : 40mm, 45mm, 60mm)  
 Perform the splice (compatibility: 40mm, 45mm, 60mm)

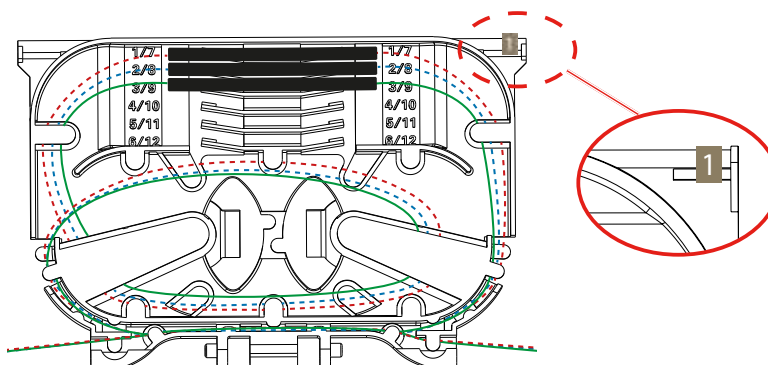

Réaliser l'épissure (compatibilité : 40mm, 45mm, 60mm)  
 Perform the splice (compatibility: 40mm, 45mm, 60mm)

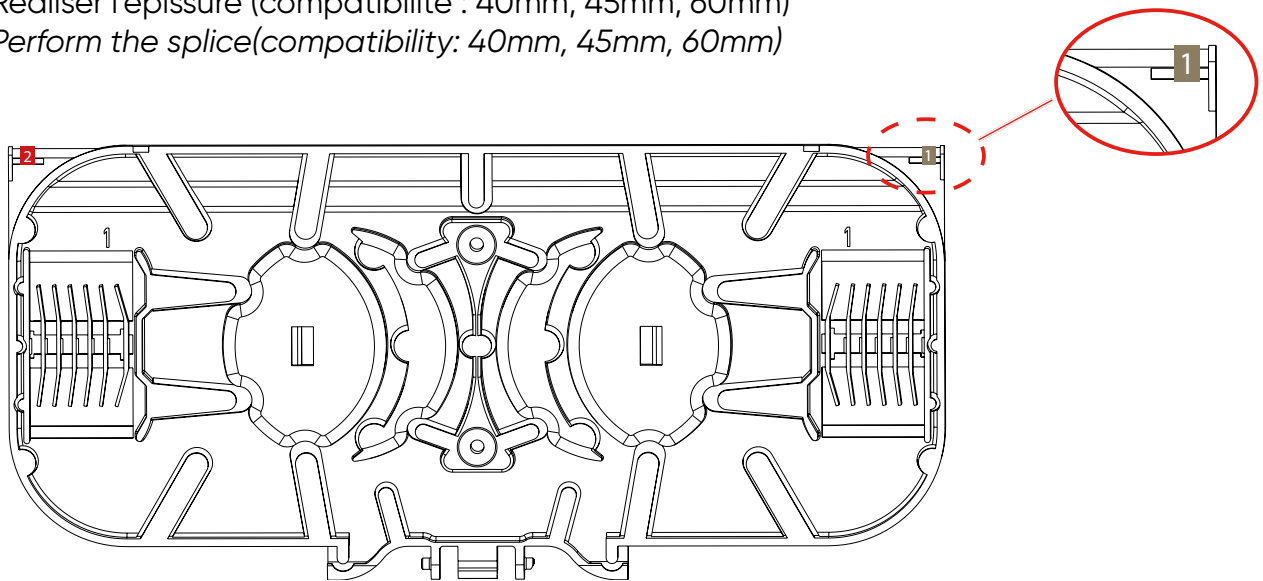

**4. FERMETURE DU BATTANT**  
**CLOSING THE MODULE**



**1** Clipper le capot  
 Clip the cover



**2** Refermer le battant  
 Close the swiveling chassis

## 5. POSE D'UN CORDON INSTALLING PATCHCORD



**1** Ouvrir le volet de la goulotte  
et connecter la fiche  
*Open the shutter of the cableway  
and connect the patchcord*

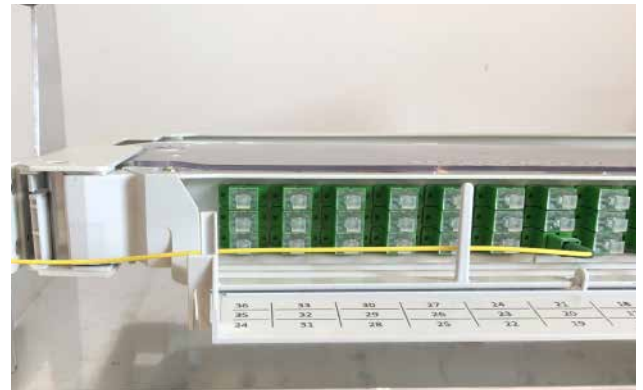

**2** Insérer le cordon dans la goulotte et  
le faire cheminer côté axe de rotation du module  
*Insert the patchcord in the cableway and routing  
in the good rotating side*

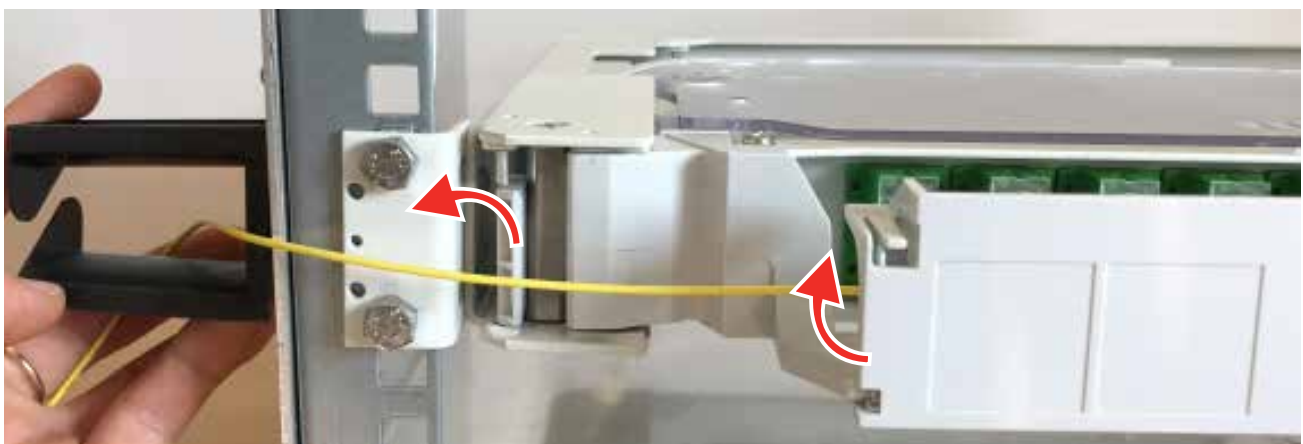

**3** Passer le cordon dans l'anneau de guidage  
(si l'armoire en est équipée)  
*Routing the patchcord in the spool clip  
(if the cabinet is fitted)*

**4** Refermer le volet  
*Close the shutter*

## 6. ÉLÉMENTS PARTICULIERS DE MAINTENANCE SPECIAL PROCEDURES FOR MAINTENANCE

### 6.1. Remplacement d'un raccord Adapter replacement

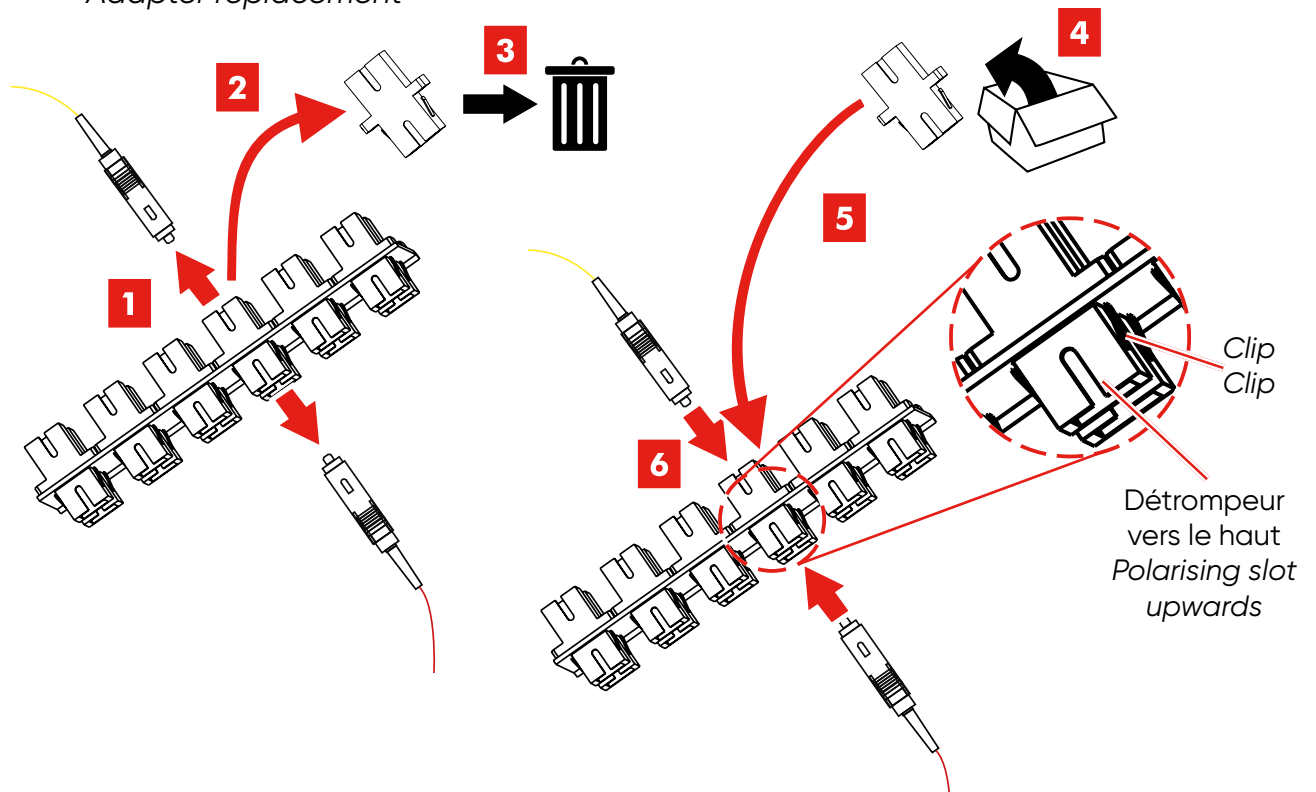

## 6.2. Principe de dépose du plateau Module replacement

- 1** Décabler le plateau  
*Unwire the module*

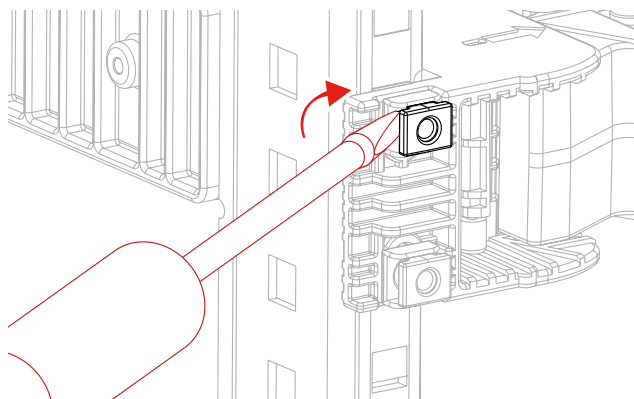

- 2** Retrait du pion du montant avant gauche  
*Remove pawn from the left front frame*

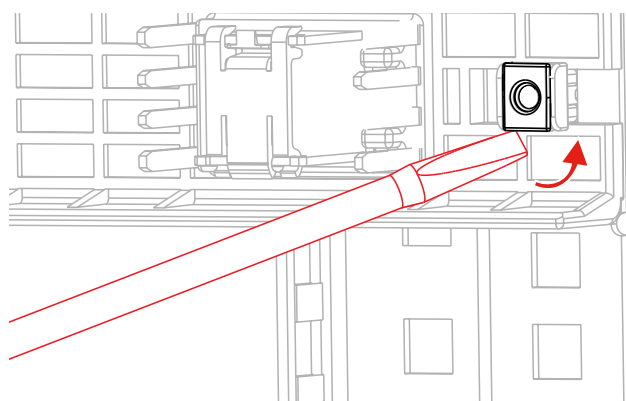

- 4** Ouverture du battant et retrait  
du pion du montant arrière  
*Open the swiveling chassis and remove  
the pawn from the back frame*



- 5** Tirer le plateau  
*Pull the module*

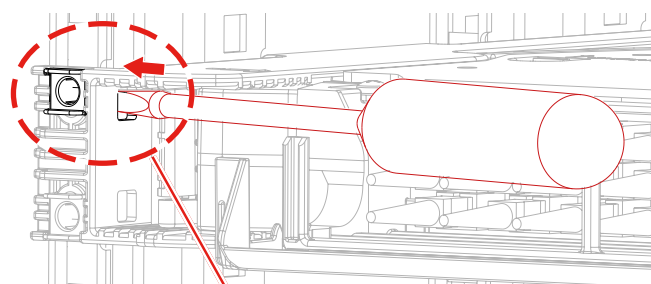

Vue de dessus  
Top view

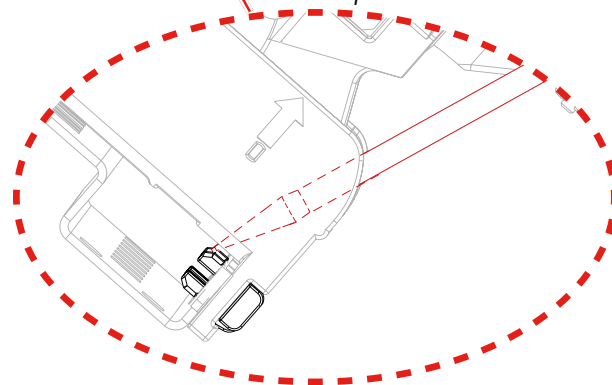

- 3** Retrait de la douille du montant avant gauche  
*Remove socket from the left front frame*

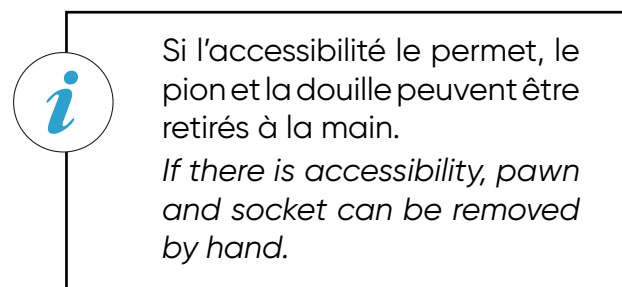

- 6** Retrait du pion et de la douille de la  
plaque de verrouillage du montant avant droit  
*Remove pawn and socket from the locking plate  
of the right front frame*

## 7. ANNEXES ANNEX

### 7.1. Mise en place d'un coupleur *Installation of a splitter*

#### 7.1.1. Mise en place d'un coupleur 1:32 avec branches préconnectées *Installation of 1:32 splitter with preterminated outputs*

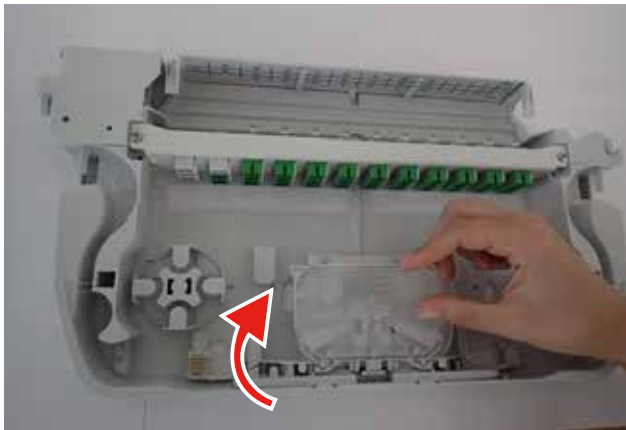

**1** Faire pivoter la cassette  
*Rotate the cassette*

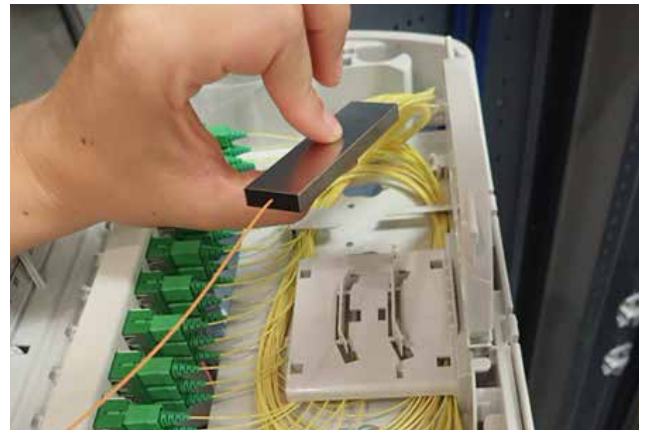

**2** Mise en place du coupleur 1:32  
*Installing the 1:32 splitter*

**3** Lovage des branches et du/des tronç(s)  
*Coiling the outputs and the input(s)*

#### 7.1.2. Mise en place d'un coupleur 1:64 avec branches préconnectées *Installation of 1:64 splitter with preterminated outputs*



**1** Faire pivoter la cassette  
*Rotate the cassette*



**2** Couper la partie sécable  
du support coupleurs 1:32  
*Cut the scored parts of  
the 1:32 splitters holder*

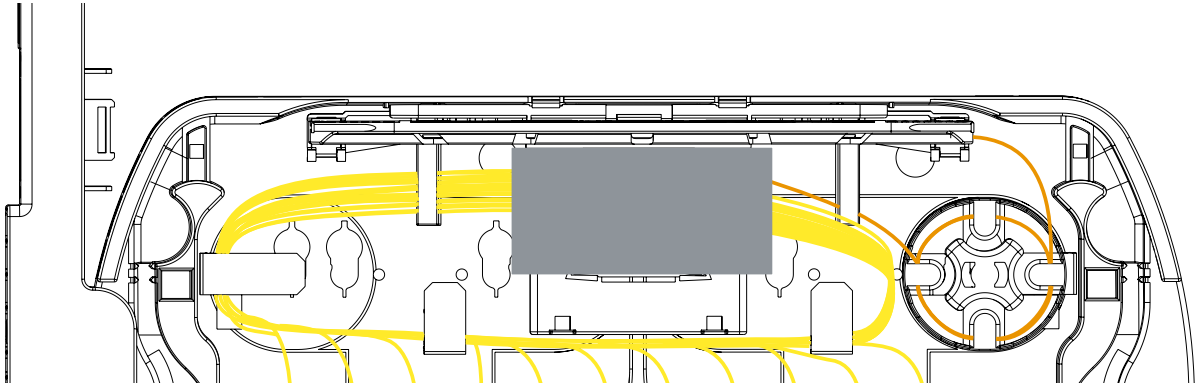

**3** Mise en place du coupleur 1:64  
*Installing the 1:64 splitter*

**4** Lovage des branches et du/des tronc(s)  
*Coiling the outputs and the input(s)*

7.1.3. Mise en place d'un coupleur 1:2/1:4/1:8/1:16 avec branches préconnectées  
*Installation of 1:2/1:4/1:8/1:16 splitter with preterminated outputs*



**1** Faire pivoter la cassette  
*Rotate the cassette*



**2** Couper les parties sécables  
du support coupleurs 1:32  
*Cut the scored parts of the 1:32 splitters holder*



**3** Mise en place des supports coupleur(s) (I)  
*Installing the splitter(s) holders (I)*



**4** Mise en place du/des coupleur(s)  
*Installing the splitter(s)*  
**5** Lovage des branches et du/des tronc(s)  
*Coiling the outputs and the input(s)*

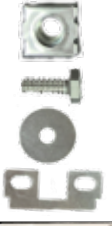
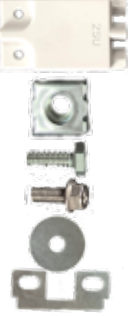

7.2. Autres kits à approvisionner en supplément  
*Others kits to be ordered separately*

		Description	Qté / Qty
Kit de fixation 19" (□↑9,5mm) :			<i>19" fixation kit (□↑9.5mm):</i>
<b>m</b>	– Écrous cages (□↑9,5mm)	– Cage nuts (□↑9.5mm)	<b>5</b>
<b>e</b>	– Vis hexagonales	– Hexagonal screws	<b>5</b>
<b>f</b>	– Rondelle	– Washer	<b>1</b>
<b>g</b>	– Plaques de renfort	– Reinforcing plates	<b>2</b>
Kit de fixation ETSI (□↑8,3mm) :			<i>ETSI fixation kit (□↑8.3mm):</i>
<b>n</b>	– Verrou ETSI 2SU	– Lock ETSI 2SU	<b>1</b>
<b>d</b>	– Écrous cages (□↑8,3mm)	– Cage nuts (□↑8,3mm)	<b>5</b>
<b>e</b>	– Vis hexagonales	– Hexagonal screws	<b>3</b>
<b>o</b>	– Vis hexagonales à embase	– Hexagonal base screws	<b>2</b>
<b>f</b>	– Rondelle	– Washer	<b>1</b>
<b>g</b>	– Plaque de renfort	– Reinforcing plate	<b>1</b>

### 7.3. Fixation avec écrous cages sur montants 19" Cage nuts fixation on 19" frames

Utiliser les écrous cages  $\square\updownarrow 8,3\text{mm}$  ou  $\square\updownarrow 9,5\text{mm}$  dans le cas où l'utilisation du système douilles-pions ne fonctionne pas.

Use cage nuts  $\square\updownarrow 8.3\text{mm}$  or  $\square\updownarrow 9.5\text{mm}$  if the utilisation of the pawns-sockets kit cannot be used.



Kit de fixation 19" ( $\square\updownarrow 8,3\text{mm}$  ou  $9,5\text{mm}$ ).

19" fixation kit ( $\square\updownarrow 8.3\text{mm}$  or  $9.5\text{mm}$ ).



**c**  
1U



**d/l**  
x5



**e**  
x3



**f**  
x1



**g**  
x2



Sens de l'écrou cage sur les montants: clips vers le haut.  
Position of the cage nut in the frames: clips upward.

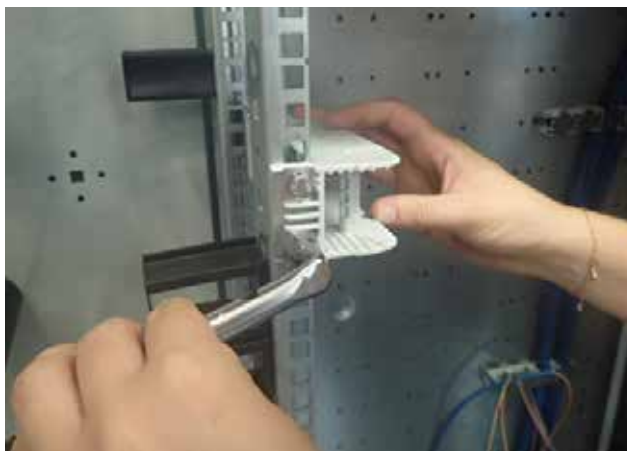
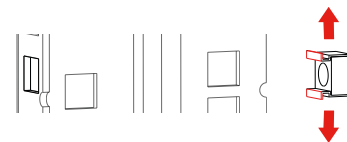

**1** Montant avant gauche (e + g + d/l)  
Left front frame (e + g + d/l)



**2** Montant arrière (e + f + d/l)  
Back frame (e + f + d/l)



**3** Montant avant droit (c + e + g + d/l)  
Right front frame (c + e + g + d/l)



N'oubliez pas les plaques de renfort (g).

Do not forget the reinforcing plates (g).

#### 7.4. Fixation du kit de guidage Routing kit fixation















Utiliser le kit de guidage dans le cas où les armoires ne sont pas pourvues d'anneaux de guidage latéraux.

Use the routing kit if the cabinets are not provided with lateral routing rings.



**i** Kits de fixation 19"/ ETSI et kit bobine.

19"/ ETSI fixation kits and spool kit.

Kit ETSI	 <b>e</b> x3	 <b>d/l</b> x5	 <b>o</b> x2	 <b>f</b> x1	 <b>n</b> 2SU	 <b>g</b> x1
Kit 19"	 <b>c</b> 1U	 <b>d/l</b> x5	 <b>e</b> x3	 <b>f</b> x1	 <b>g</b> x2	
Kit bobine	 <b>j</b> x1	 <b>k</b> x1	 <b>h</b> x1	 <b>i</b> x1		



Sens de l'écrou cage sur les montants: clips vers le haut.  
Position of the cage nut in the frames: clips upward.

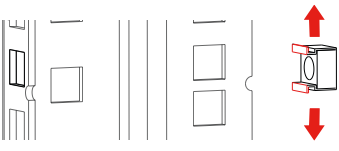

**1**

Montage du kit bobine (h + i + j + k)  
Mounting of the spool kit (h + i + j + k)

Cas d'une armoire au format ETSI  
*In the case of an ETSI cabinet*



**2** Montage du kit bobine sans plaque (d + e)  
*Mounting spool kit without plate (d + e)*



**3** Montant avant droit (o + n + d)  
*Right front frame (o + n + d)*

Cas d'une armoire au format 19"  
*In the case of a 19" cabinet*



**2** Montage du kit bobine sans plaque (e + d/l)  
*Mounting spool kit without plate (e + d/l)*



**3** Montant avant droit (c + e + g + d/l)  
*Right front frame (c + e + g + d/l)*



**4** Montant arrière (e + f + d/l)  
*Back frame (e + f + d/l)*

**8. INSTRUCTION DE FIN DE VIE**  
**END LIFE INSTRUCTION**



**9. TRAÇABILITÉ**  
**TRACEABILITY**



Le numéro de série est situé à l'arrière du plateau.

*The serial number is located at the back of the module.*

Se connecter via LinkedIn  
Connect via LinkedIn



En savoir plus sur Youtube  
Learn more on YouTube

Visiter [www.aginode.net](http://www.aginode.net)  
Visit [www.aginode.net](http://www.aginode.net)

Contactez-nous via  
Contact us via  
[info@aginode.net](mailto:info@aginode.net)

AGINODE  
25, avenue Jean Jaurès  
08330 Vrigne-aux-Bois  
FRANCE  
Tel. +33 (0) 3 24 52 61 61